

AccuForce 12V - 140Ah S

Solar VRLA Battery



Specifications

Nominal Voltage	12 V	
Number of cells	6	
Cycle Life	Approx. 800 cycles at 50% DOD	
Dimensions	Length	409 mm
	Width	176 mm
	Height	225 mm
	Total Height	225 mm
Approx. Weight	33.5 kg	
Nominal Capacity (25°C)	120 hours rate (1.17 A, 11.1 V)	140.4 Ah
	100 hours rate (1.40 A, 11.1 V)	140.0 Ah
	48 hours rate (2.76 A, 10.8 V)	132.5 Ah
	10 hours rate (12.0 A, 10.8 V)	120.0 Ah
	5 hours rate (21.0 A, 10.5 V)	105.0 Ah
Max. Discharge Current (25°C)	1200 A (5s)	
Internal Resistance	4.0 mOhms	
Fully Charged battery (25°C)		
Self-Discharge	3% of capacity declined per month at 25°C (average)	
Operating Temperature Range	Discharge	-15°C~50°C
	Charge	-10°C~50°C
	Storage	-20°C~50°C
Short Circuit Current	2950 A	
Charging Characteristics (25°C)	Cycle use	2.40-2.48 Vpc
	Maximum charging current	36 A
	Temperature compensation	-30 mV/°C
	Standby use	2.27-2.35 Vpc
Design Floating Life (20°C)	Temperature compensation	-18 mV/°C
		10 years

Applications

- Solar / Wind power systems
- Residential installations
- Golf carts and electric powered vehicles
- Marine equipment
- Electric wheelchairs
- Traffic systems (signaling and lighting)
- Remote monitoring and controlling
- Power tools and cleaning machines
- Uninterruptible power supply (UPS)

Battery Construction

Component	Positive Plate	Negative Plate	Container	Cover	Safety Valve	Terminal	Separator	Electrolyte
Raw material	Lead dioxide	Lead	ABS	ABS	Rubber	Copper	Fiberglass	Sulfuric acid

Dimensions

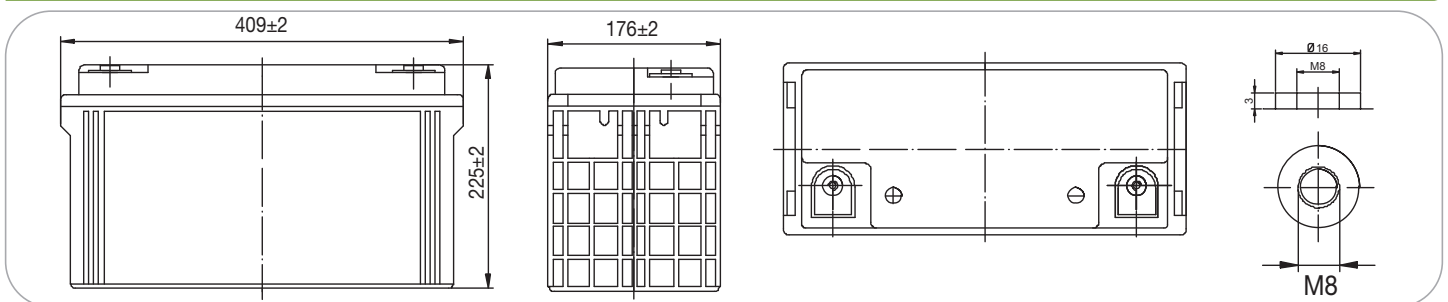

Constant Current Discharge (Amperes) at 25°C

End Voltage (Volts/Cell)	15min	30min	1h	2h	3h	4h	5h	6h	8h	10h	20h	48h	72h	100h	120h
1.60 V	201	121	75.0	43.8	30.6	25.1	21.5	18.6	14.6	12.2	6.41	---	---	---	---
1.65 V	195	119	74.1	43.5	30.5	24.9	21.3	18.3	14.6	12.2	6.39	---	---	---	---
1.70 V	189	115	72.2	43.2	30.3	24.8	21.2	18.3	14.5	12.1	6.39	2.81	---	---	---
1.75 V	182	112	70.7	42.6	30.0	24.6	21.0	18.3	14.4	12.1	6.35	2.63	1.88	---	---
1.80 V	171	108	68.6	41.6	29.1	23.9	20.4	17.7	13.9	12.0	6.30	2.76	1.86	---	---
1.85 V	161	102	64.4	39.0	27.3	22.4	19.2	16.7	13.1	11.3	5.93	2.60	1.76	1.40	1.17

Constant Power Discharge (Watts) at 25°C

End Voltage (Volts/Cell)	15min	30min	1h	2h	3h	4h	5h	6h	8h	10h	20h	48h	72h	100h	120h
1.60 V	2196	1347	854	504	357	291	252	219	174	145	76.8	---	---	---	---
1.65 V	2144	1325	843	501	356	291	249	216	174	145	76.7	---	---	---	---
1.70 V	2064	1287	824	498	353	288	249	216	173	144	76.5	33.6	---	---	---
1.75 V	1994	1257	807	492	351	287	246	213	171	144	76.2	33.5	22.5	---	---
1.80 V	1889	1215	783	480	341	281	242	209	165	143	75.6	33.2	22.4	---	---
1.85 V	1773	1140	735	450	320	263	227	195	155	134	71.1	31.2	21.0	16.8	14.1

Note: The above characteristics data can be obtained within three charge/discharge cycles.

AccuForce 12V - 140Ah S

Solar VRLA Battery

Typical Use Life and Operating Temperature

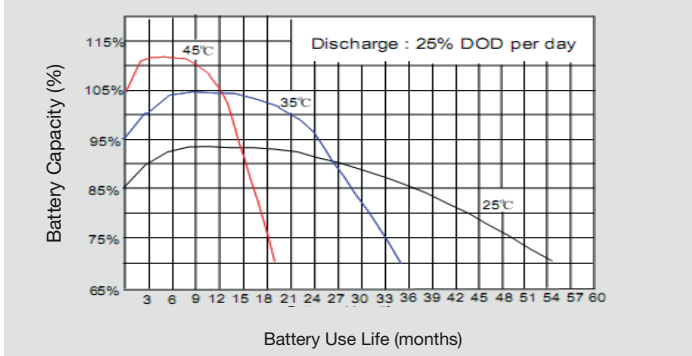

Self Discharge Characteristics

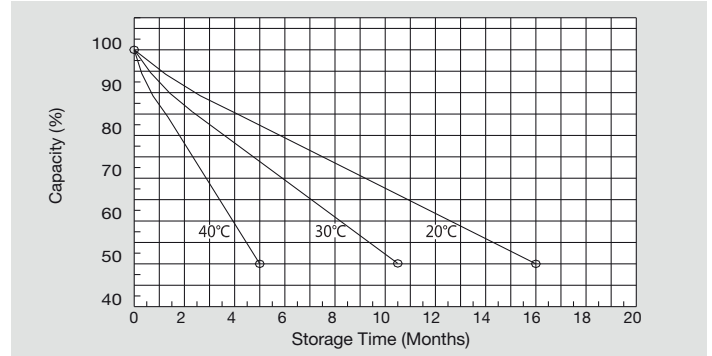

Discharge Characteristics (25°C)

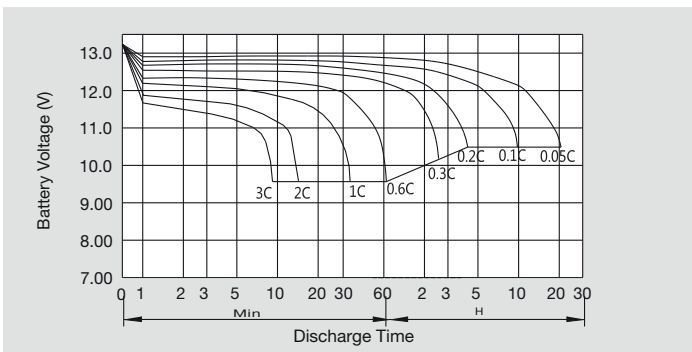

Charging Characteristics (25°C)

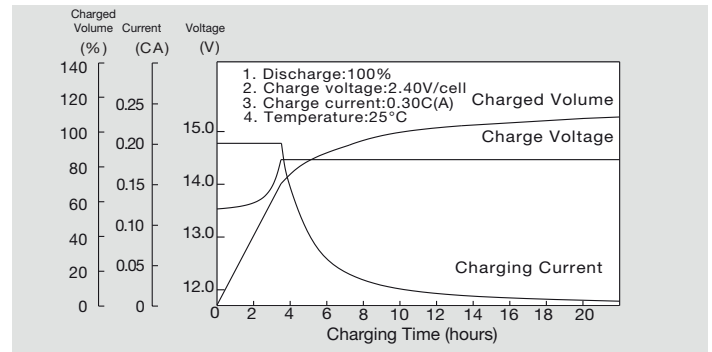

Relationship Between Charging Voltage and Temperature

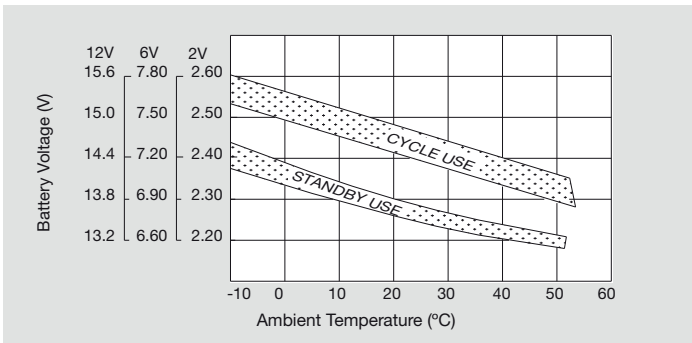

Relationship Between OCV and Residual Capacity (25°C)

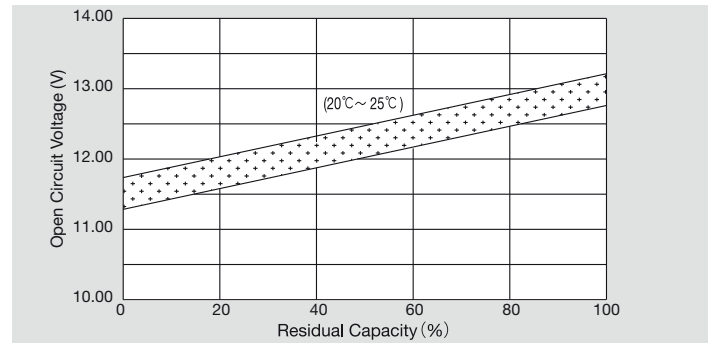

Cycle Service Life in Relation to Depth of Discharge

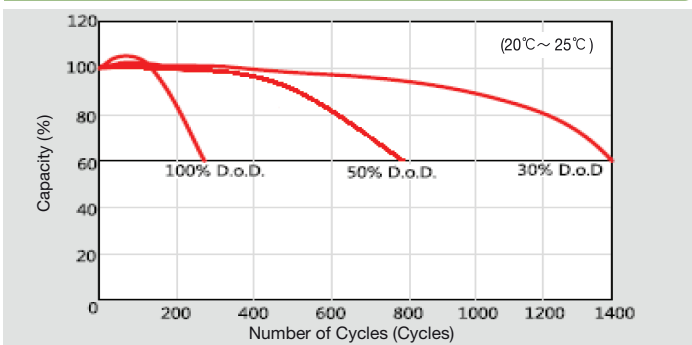

Temperature Effects on Capacity

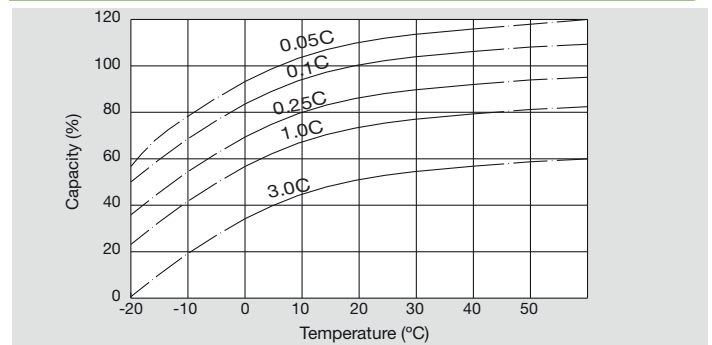

Headquarters 2 Ermou & Nikis Street | Syntagma Square | 105 63 | Athens | Greece | EU
 Manufacturing Plant Neo Olvio | 672 00 Xanthi | Greece | EU
 Recycling Plant Industrial Area of Komotini | 691 00 Komotini | Greece | EU
 Southeast Europe Industrial Sales 14B Menexedon Street | 145 64 Kato Kifissia | Greece | EU
 European Battery Assembly (SEBA) 175, Via Stra | 37030 Colognola Ai Colli Verona | Italy | EU
 Industrial SRL 11, Soseaua Centurii | 077025 Bragadiru, Judet Ilfov | Romania | EU

T +30 210 6245400
 T +30 25410 48100
 T +30 25310 82460
 T +30 210 6245600
 T +39 045 7651771
 T +40 021 3517777

F +30 210 6245409
 F +30 25410 95446
 F +30 25310 82489
 F +30 210 6245619
 F +39 045 7651771
 F +40 021 3516667